







m.e.a.a.t.

macchine agricole ed enologiche - Città di Castello - Perugia - Italia

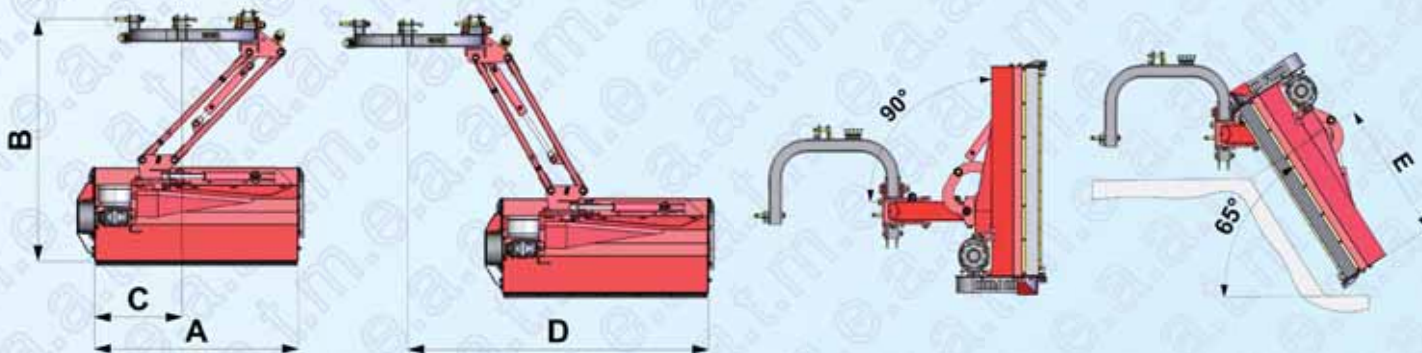



TLL





Mod.	A cm	B cm	C cm	D cm	E cm	hp	kW			
TLL 135	135	130	65	180	115	25-30	18-22	260	20	40
TLL 155	155	130	65	200	135	30-45	22-33	280	24	42

 **Trinciasarmenti leggero con inclinazione e spostamento laterale idraulici Mod. TLL**
Utilizzo: bordi stradali, terrapieni, fossati, potature fino a 5 cm di diametro, erba, ecc...
Caratteristiche: ampia area d'inclinazione, basso assorbimento di potenza, alta produttività.
Dotazione di serie: attacco a tre punti, moltiplicatore con ruota libera, martelli (coltelli Y su richiesta), sistema meccanico di sicurezza, rullo posteriore regolabile, slitte laterali, martinetto per inclinazione con valvola paracadute, martinetto per spostamento laterale con valvola di blocco pilotata a doppio effetto, piedini di supporto, bandierine di protezione anteriori, gomma di protezione posteriore, protezioni antifortunistiche a normativa CE.
Accessori: albero cardanico standard o omocinetico.

 **Light-duty Central and Offset Shredder with hydraulic inclination and side shift Mod. TLL**
Use: banks, lanes, embankments, pruning up to 5 cm diameter, grass, etc.
Features: wide area of inclination, low power absorption, high productivity.
Standard equipment: three-point hitch, gearbox with free wheel, hammers (alternatively, Y blades), mechanical safety device, adjustable rear roller, side skids, jack for inclination with automatic check valve, hydraulic jack for side shift with double acting driven check valve, support legs, protecting front flaps, rear rubber, CE covers.
Accessories: standard or wide-angle PTO drive shaft.

 **Broyeur d'accotement léger avec inclinaison et déport hydrauliques Mod. TLL**
Emploi: talus, accotements, voiries, bois de taille jusqu'à 5 cm de diamètre, herbe, etc.
Caractéristiques: inclinaison maximum, absorption de puissance contenue, haute productivité.
Équipement de série: attelage à trois points, boîtier avec roue libre, marteaux (couteaux Y en option), sécurité mécanique, rouleau arrière réglable, patins latéraux, vérin hydraulique pour inclinaison avec valve pare-chute, vérin hydraulique pour déplacement latéral avec clapet de blocage piloté à double effet, béquilles de stockage, volets anti-projection antérieurs, protection en caoutchouc arrière, protections à la norme CE.
Accessoires: cardan normal ou homocinétique.

 **Mulchgerät, leicht, mit hydraulischer Neigung und Seitenverschiebung Mod. TLL**
Nutzung: Straßenränder, Wälle, Gräben, Holzabfälle bis 5 cm Durchmesser, Gras, usw.
Eigenschaften: großes Neigungsfeld, niedrige Leistungsaufnahme, hohe Produktivität.
Serienausstattung: Dreipunktabbock, Freilaufgetriebe, Hämmer (bzw. Y-Messer), mechanische Anfahrtsicherung, regulierbare Heckwalze, seitliche Kufen, Zylinder zur Neigung mit Rohrbruchsicherungsbuchse, Zylinder zur Seitenverschiebung mit gesteuertem doppelwirkendem Sperrventil, Stützfüße, Frontpendelschutzklappen, Heckschutzgummi, CE Schutz.
Zubehör: Standard- oder Weitwinkelgelenkwelle.

 **Trituradora de sarmientos liviana con inclinación y desplazamiento lateral hidráulicos Mod. TLL**
Uso: bordes de carreteras, terraplenes, orillas de zanjas, restos de poda de hasta 5 cm de diámetro, hierba, etc.
Características: amplia área de inclinación, baja absorción de potencia, elevada productividad.
Equipamento de serie: enganche de tres puntos, multiplicador con rueda libre, martillos (cuchillas Y en alternativa), sistema mecánico de seguridad, rodillo trasero regulable, patines laterales, cilindro para la inclinación con válvula paracaídas, cilindro para el desplazamiento lateral con válvula de bloqueo guiada de doble efecto, pies de aparcamiento, aletas de protección anteriores, goma de protección trasera y protecciones antiaccidentes previstas por las normas CE.
Accesorios: cárдан estándar u omocinético.



macchine enologiche agricole alto tevere - Soc. Coop. a r.l.

Via Dell'industria, 3 - Cinquemiglia
 06012 Città di Castello (Perugia) - Italy

Tel. 0039 075 8642111 r.a. - Fax 0039 075 8540803

e-mail: info@meaat.com - web site: www.meaat.com



Sistema meccanico di sicurezza.
 Mechanical safety device.
 Sécurité mécanique.
 Mechanische Anfahrtsicherung
 Sistema mecánico de seguridad.